

# COSMOLINE

Technical data pages by Formrack

Cosmoline 19" Free Standing Rack  
Cabinet Reference Rack:36U 600x1000

**FORMRACK®**



## General Features

- Cosmoline cabinets have four side openable, lockable and easily removable covers.
- The rear and side covers are made by DKP sheet and the front side is made by 4 mm thick, impact-resistant, tempered and smoked-colored glass which is supported by metal frames.
- The frame and corner profiles have nested structure and this structure provides high strength.
- Ventilation can be provided by cooling units with 2 , 4 or 6 fans.
- 36U height option.
- There are four 19" mounting profiles which can be adjusted in depth according to the need in the cabinet
- Mounting profiles have U markings that facilitate the mounting process.
- At the bottom part of the cabinets, there is a sliding and dust-protected brushed cable entry. These entries are available in two locations, from bottom to top.
- Painted by impact-resistant,high strength, electrostatic Ral 9005 texture black color or Ral 7035 gray.
- All test procedures have been carried out and has RoHS, CE, EN 61587-1 standards.

## Technical Descriptions

Dimensions W*D	: W:600 mm D:1000 mm
Available U - Sizes	: 36U
Paint Type	: Electrostatic powder paint
Standarts	: In accordance with the standard TS EN IEC 61587-1: 2022 / ISO9001-2015 / ISO14001-2015 / ISO 45001-2018 / ISO 27001:2017 / RoHS / UL 2416
Material	: Sheet Steel, DIN EN 1030-99 / DC-01 6112 / DC-7122
Load Carrying Capacity	: 1200kg / 2 645.55lbs
IP rating	: IP20
Available Colors	: Ral 9005 Black / Ral 7035 Light Gray (Contact your sales representative for different colors)

COSMOLINE

### FORMRACK

Address: Akcaburgaz Mah. 592. Sokak No:10 B Blok 34522 Esenyurt - Istanbul - Türkiye  
T: +90 212 565 56 50 / F: +90 212 567 40 46 www.formrack.com / sales@formrack.com

# COSMOLINE

Technical data pages by Formrack

Cosmoline 19" Free Standing Rack  
Cabinet Reference Rack:36U 600x1000

**FORMRACK®**



■ RAL 9005



■ RAL 7035



## DOORS

Front Doors



Single Glass Door



Single Perforated Door



Double Perforated Door

Rear Doors



Single Solid Metal Door



Double Solid Metal Door

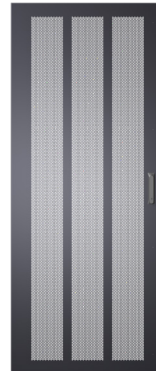

Single Perforated Door



Double Perforated Door

COSMOLINE

**FORMRACK**

Address: Akcaburgaz Mah. 592. Sokak No:10 B Blok 34522 Esenyurt - İstanbul - Türkiye  
T: +90 212 565 56 50 / F: +90 212 567 40 46 [www.formrack.com](http://www.formrack.com) / [sales@formrack.com](mailto:sales@formrack.com)

# COSMOLINE

Technical data pages by Formrack

Cosmoline 19" Free Standing Rack  
Cabinet Reference Rack:36U 600x1000

**FORMRACK**

## Exploded View

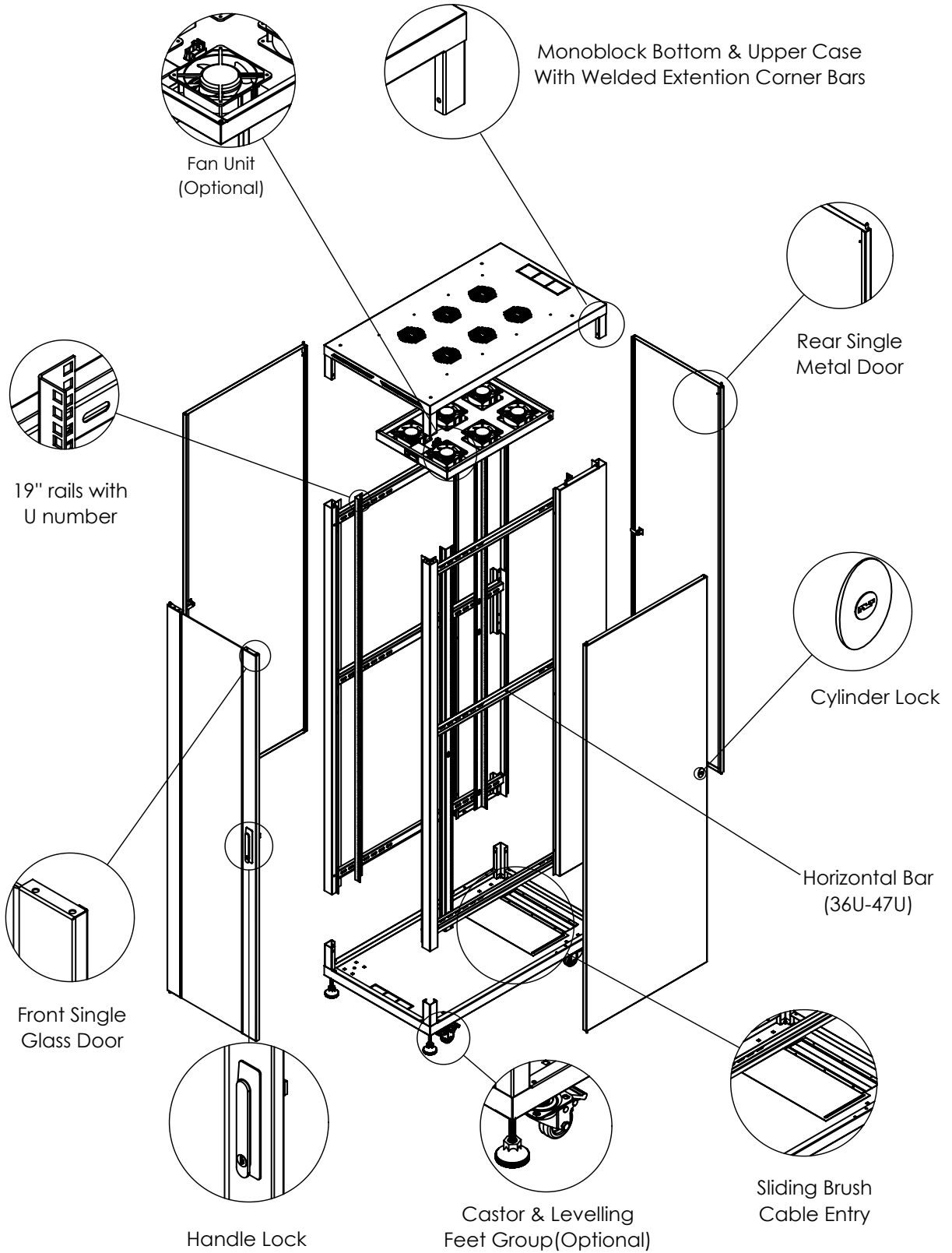

COSMOLINE

**FORMRACK**

Address: Akcaburgaz Mah. 592. Sokak No:10 B Blok 34522 Esenyurt - Istanbul - Türkiye  
T: +90 212 565 56 50 / F: +90 212 567 40 46 [www.formrack.com](http://www.formrack.com) / [sales@formrack.com](mailto:sales@formrack.com)

# COSMOLINE

Technical data pages by Formrack

Cosmoline 19" Free Standing Rack  
Cabinet Reference Rack:36U 600x1000

**FORMRACK®**

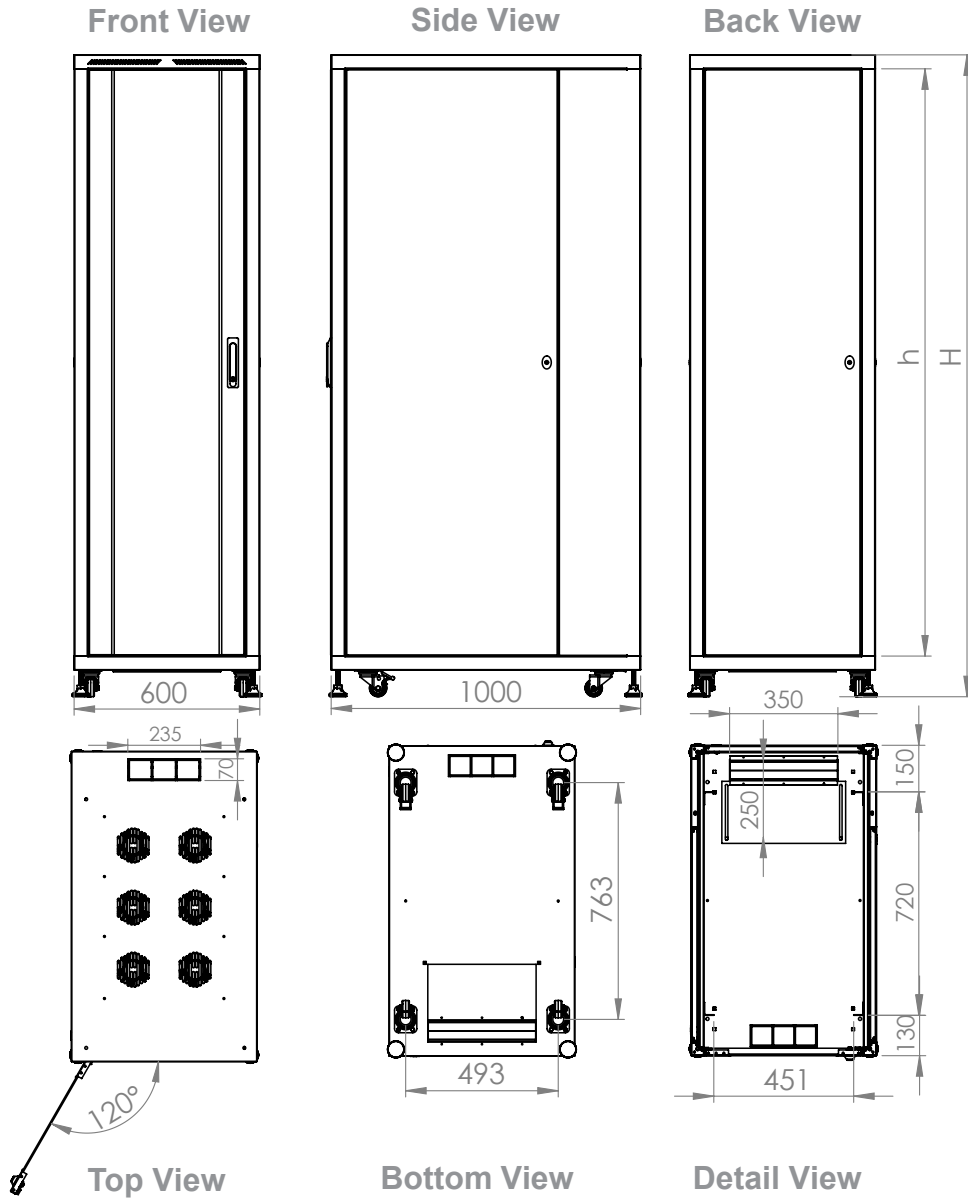

Product Number	Product Name	Dimensions (WxDxH) (mm)	U	H (mm)	h (mm)	Weight (kg)
FORM CSM-36U60100	36U 600x1000 COSMOLINE FREE STANDING CABINET	600x1000x1831	36	1831	1603	87

COSMOLINE

**FORMRACK**

Address: Akcaburgaz Mah. 592. Sokak No:10 B Blok 34522 Esenyurt - Istanbul - Türkiye  
T: +90 212 565 56 50 / F: +90 212 567 40 46 [www.formrack.com](http://www.formrack.com) / [sales@formrack.com](mailto:sales@formrack.com)

## STANDARDS

### PROTECTION INDEX

- IP20 According to TS 3033 EN 60529
- IP20 :Rigid test rod diameter of 12 mm, 80 mm long (as specified by the standard) is pushed against any openings of the enclosure with the force of 10N

### MECHANICAL PERFORAMANCE

- EN 61587-1 5.2.1 / 5.2.3
- Static mechanical load test (Performance level SL06)
- Resonance point detection test IEC 60068-2-6
- Rolling Test (TS EN IEC 61587-1)
- Vibration test (IEC 60068-2-6)
- Shock test IEC 60068-2-27)

### CLIMATIC TESTS (Performance level C2)

- Cold (IEC 60068-2-1) Temperature of the exposure: -25°C +/-3°C
- Dry heat (IEC 60068-2-2) Temperature of the exposure: +70°C +/-2°C
- Damp heat cyclic (IEC 60068-2-30)

### INDUSTRIAL ATMOSPHERE (Performance level A2)

- Sulphur dioxide test and hydrogen sulphide test IEC 60068-2-42, IEC 60068-2-43, IEC 60068-2-49

### GROUNDING CONTINUITY

EN 61587-1 / EN 61010-1

The continuity of the protection circuit is in accordance with the standard regulations, measured resistance was less than 0.1 Ohm.

**SHEET METAL:** TS EN ISO 9001:2008; TS EN 10130 :2006; DIN EN 1030- EQV; BS EN 1030-EQV; NF A36-401.

**ELECTROSTATIC POWDER PAINT:** ISO 9001:2015 ASTM D523; ASTM D2794; DIN EN ISO 2811-1; ASTM D1186/D1400; Ral:9005 or Ral:7035.

**VENTILATION UNITS ( Fan Unit )** TS EN 62368-1:2020 — AC:2020 — A11:2020

**TEMPERED SAFETY GLASS** " EN 12150 – 2 Glass, Tempered, secure " Mechanical strength test result: Bending strength minimum 120 N/ mm<sup>2</sup>

**CONNECTION COMPONENTS** (screw, nut, washer etc.)" TS EN ISO 7045; TS EN ISO 4032; RoHS IEC 62321 "

**WHEEL SET** " TS EN 12532 , TS EN 12533 , RoHS IEC 62321:2008"

**LOCKS SYSTEMS** "DIN-EN ISO 1043-1 PA6 GFR 30; DIN-EN 1774-ZnAl4Cu1.